

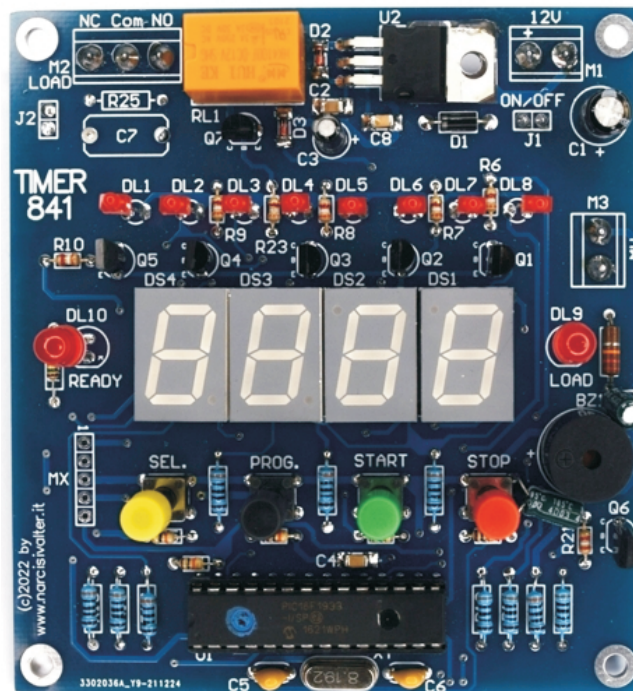

OWNER'S MANUAL

## BOARD for DR-841 Timer



**Board DR-841**  
**Programmable**  
**Darkroom Timer**  
*with 8 memories*  
(v.3)

# BOARD for DARKROOM Timer DR-841

## FEATURES:

- Input Voltage: **12Vdc** ( $\pm 5\%$ ).
- Management with **Microcontroller**.
- **Quartz** accuracy.
- **Countdown** Timer.
- **Easy** to use.
- 4 command buttons: **TIME SELECT**, **PROG**, **START** and **STOP**.
- **8 programmable Times** from **0.1sec.** to **10 minutes** (**9min.**, **59sec.**, **9dec.**).
- **Buzzer on-board** for signalling counting end and for audio scanning of last 10 seconds.
- The time and setting are **stored** in the memory of chip and retrieved during Power ON.
- **Red LED "LOAD"** for showing the activated **LOAD**.
- **Red LED "PAUSE"** for showing the Timer **PAUSED**.
- **8 Red LEDs** to indicated the selected Time.
- **3A/250V Relay output** and 3 way screw Terminal Block (**NO - Com - NC**).
- Can be activate enlarger LAMP up to **500 Watt**.
- Displaying: **50x18** mm. Red Display 7-segment (0.56").
- Board dimensions (mm.): **89 x 95**.

---

## CARATTERISTICHE:

- Tensione di alimentazione: **12Vcc** ( $\pm 5\%$ ).
- Gestione a **Microcontrollore**.
- Precisione al **Quarzo**.
- Conteggio tipo **Countdown** (conto alla rovescia).
- **Facile** da utilizzare.
- 4 pulsanti di comando: **SELEZIONE TEMPI**, **PROG**, **START** e **STOP**.
- **8 tempi programmabili** da **0.1sec.** fino a **10 minuti** (**9min.**, **59sec.**, **9dec.**).
- **Presa Programmabile** per pedale esterno (Funzione **FOCUS** oppure **Avvio/Arresto** del Timer).
- **Buzzer on-board** per segnalazione di fine conteggio e scansione audio degli ultimi 10 secondi.
- Tempi e impostazioni sono memorizzati nella **memoria** del chip e recuperati dopo l'accensione.
- **LED rosso "LOAD"** per visualizzazione stato ingranditore **Acceso**.
- **LED rosso "PAUSA"** per visualizzazione del Timer in **PAUSA**.
- **8 LED rossi** per l'indicazione del tempo selezionato dall'utente.
- **Uscita relè: AC250V 3A** su morsettiera a vite (**NA - Com - NC**).
- Attivazione di lampade fino a **500 Watt**.
- Visualizzazione su **Display rosso** 50x18 mm. a 7-segmenti (0,56" - H. 14 mm).
- Dimensioni della scheda (mm.): **89 x 95**.

# COMMAND BUTTONS & LEDs / COMANDI & SPIE

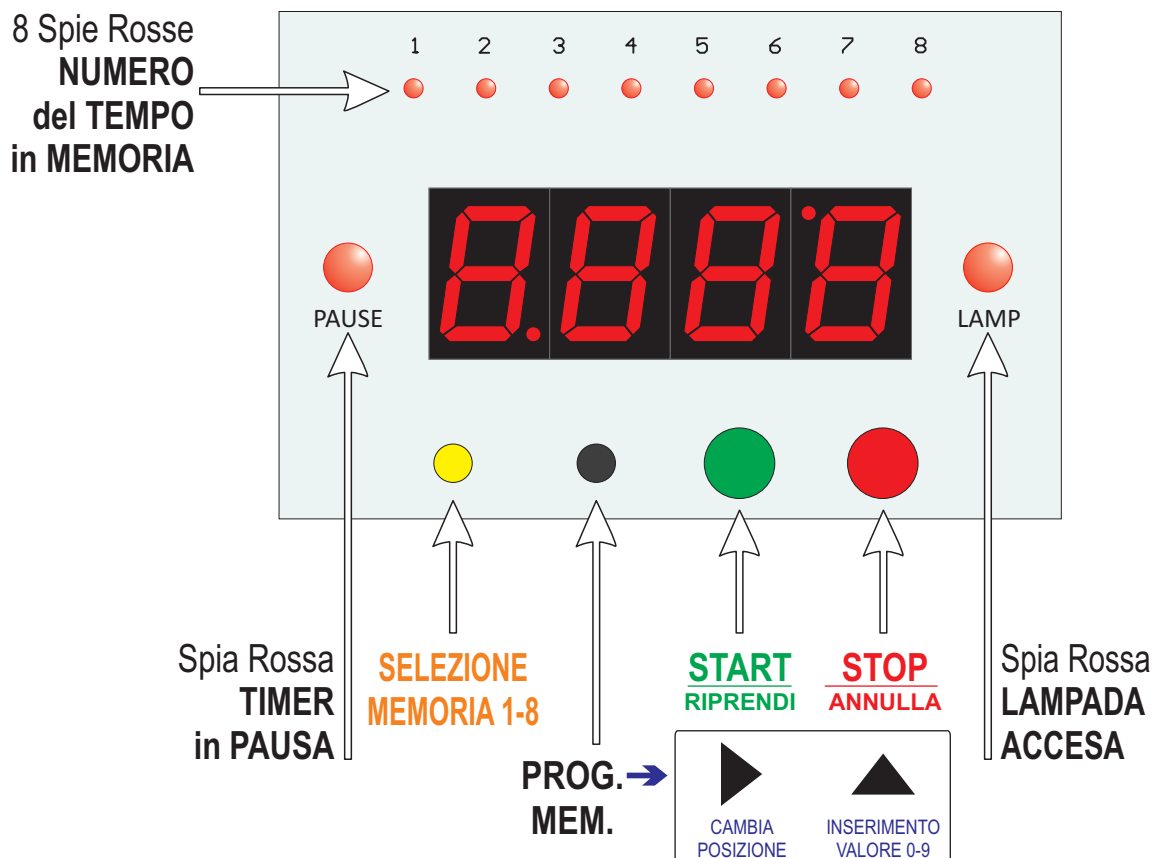
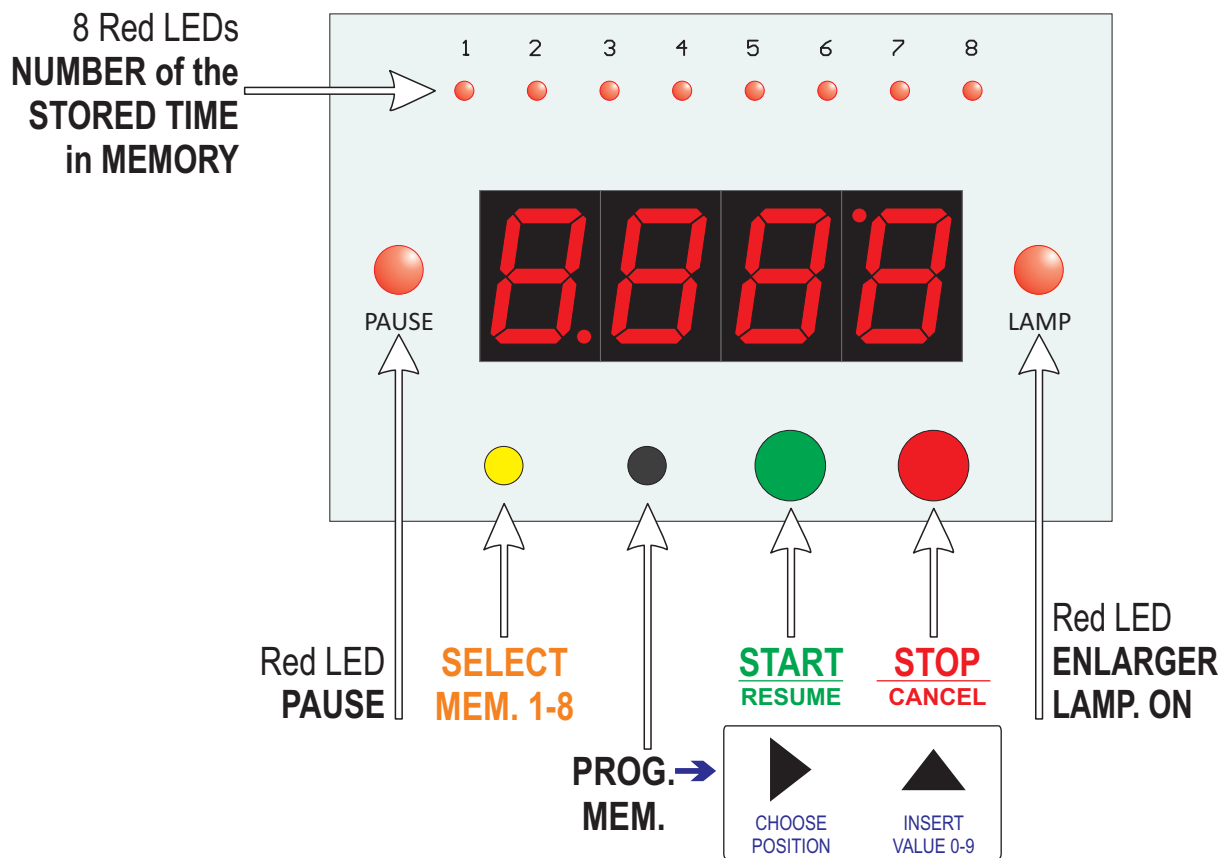

# USER'S GUIDE for DR-841

## INTRODUCTION

The **DarkRoom DR-841 Timer** manage times from **0.1 SECONDS** up to **10 MINUTES (9.59'9)** and the values to be programmed are **0.1 SECOND steps**.

After Power ON, the **Timer** displays the last time used by user: so, by pressing the **START** button, the relay is activated ("**LAMP**" LED is ON) and the Timer begins to count down. Alternatively, by pressing the **SELECT MEM.** button, one of the 8 memorized times can be selected or, by pressing the **PROG** button, enters the TIME PROGRAMMING mode: the number of the time being programmed is indicated by one of the 8 small red LEDs (for example, if LED number 5 is on, it means that we are programming Time number 5).

If there is a **black out** (and a battery has not been connected), the Timer switches off completely (the relay deactivates): when the AC main is restored, the Timer displays the last time used by the user and it is ready to be activated again.

## DEFAULT VALUES

When Power ON, the display always shows the last time used by the user (the lighting of one of the **8 red LEDs** indicates which time is shown on the display). If the Timer never been used, the default values at first Power ON are automatically sets to "**1.00'0**" (factory default).

## THE LEDs OF TIMER

In the **DR-841 Timer** there are 10 LEDs:

- **8 RED LEDs** - The red LEDs turn on one at a time and indicates the number of the Time shown in the Display.
- **PAUSED LED** - The PAUSED LED is ON only when the Timer is paused.
- **ENLARGE LAMP LED** - The ENLARGE LED is ON during the Timer is countdown (so, when the enlarger lamp is ACTIVATED).

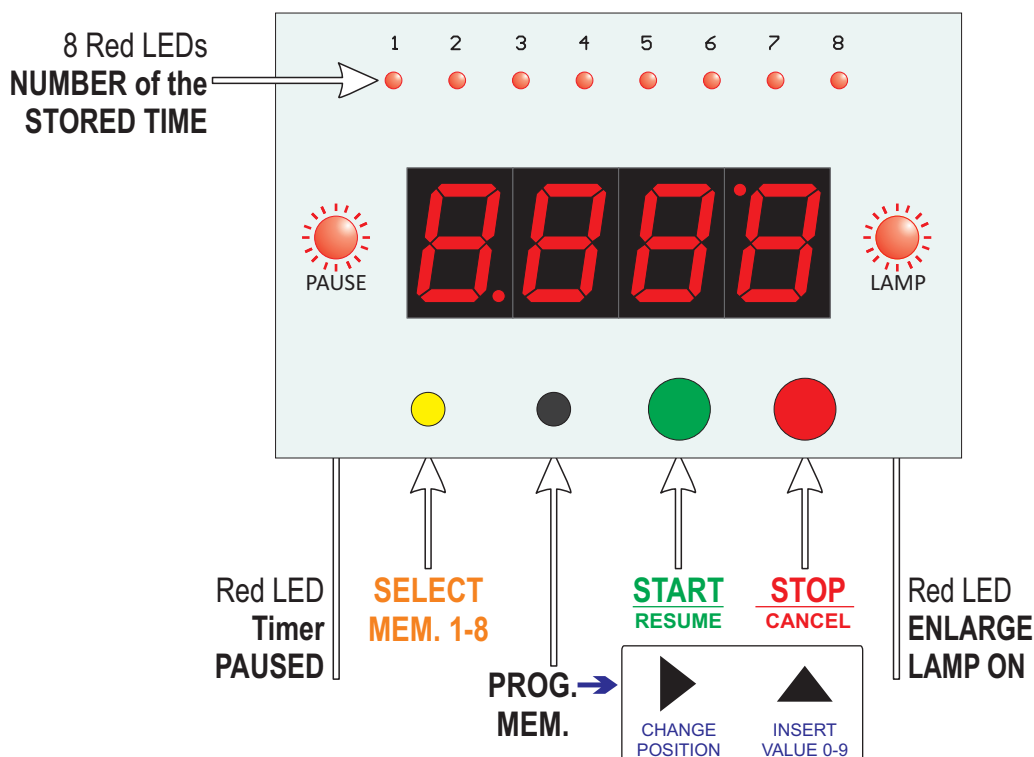

## The COMMAND BUTTONS

### SELECT the TIMES

Before start the Timer, select (if necessary) the desired time by pressing one or more times the **SELECT MEM.** button.

Each time the button is pressed, ONE of the 8 times programmed by the user will be shown on the display (the corresponding number will be indicated by ONE of the 8 red LEDs).

Once you have reached time number 8, by pressing the button again, you start again from time number 1 and so on. The time currently shown on the display and indicated by the corresponding red LED lighting up, will be the one used by the Timer at start-up (in the example on the right, Time number 4 has been selected).

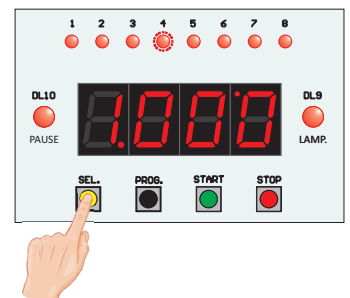
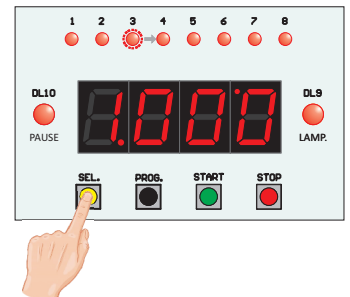
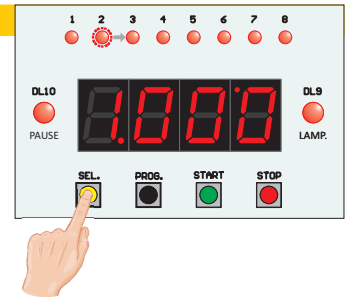

### START / RESUME

This is the button to start the Timer. When the **START** button is pressed, the Timer activates the enlarger lamp and starts the countdown (starting from the time shown on the display).

During the countdown, the red LED **"LAMP"** is on, indicating that the enlarger lamp is activated. Furthermore, the two separator dots on the display flash at a frequency of 1 Hz (low separator dot for minutes/seconds) and 10 Hz (high separator dot for seconds/tenths).

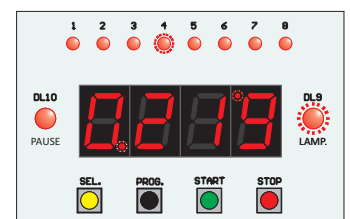
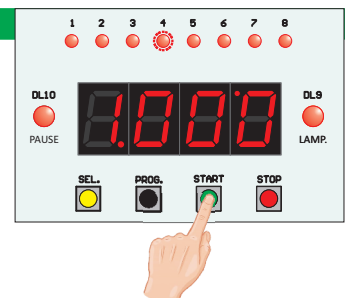

### STOP / CANCEL

This button, pressed once during the countdown, momentarily stops the Timer and turns off the enlarger lamp (the red LED **"PAUSE"** lights up to indicate that the Timer is PAUSED). To restart the Timer (and turn the enlarger lamp back on), press the **START** button otherwise, by pressing the **STOP** button a second time, the Timer will definitively abort the counting cycle, returning the Timer to the starting screen (Ready).

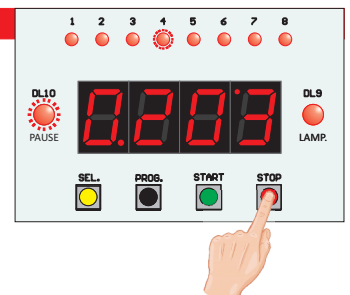

## PROGRAMMING the TIMES

Before entering the PROGRAMMING mode, choose the Time number you want program by pressing the **SELECT MEM.** button one or more times: the Time number is indicated by one of the **8 red LEDs** lighting up. There are 8 times that can be selected, so once you have reached the number eighth, pressing the button again restarts the sequence from the first LED and so on.

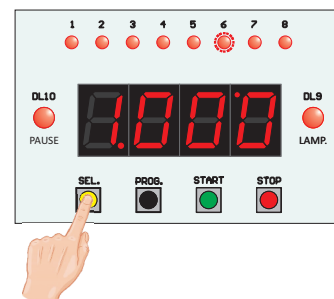

Once the desired Time to be programmed has been selected, press the **PROG. MEM.** button to enter the PROGRAMMING mode.

**NOTE** - To enter in the PROGRAMMING MODE, the Timer must be ready (so NOT paused).

During programming the Time, ONLY one digit lights up on the display at a time (i.e. the one selected for entering the value to be programmed): the remaining digits on the display are "hidden" and their positions are indicated by **underscores lighting up**.

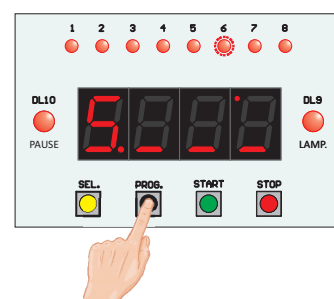

### Select the POSITION and insert the VALUE

The **START** and **STOP** buttons have a double function: when entering the PROGRAMMING mode, these two buttons allow you to choose the position of the digit to program and the relative value to enter, as described below:

- Button **▶ (START)** - Each press of the button selects a different position on the display (from left to right). In correspondence with the selected position, the digit in which the value to be programmed will be entered will be displayed. After the fourth position, pressing the button again restarts the sequence from the first position and so on.
- Button **▲ (STOP)** - Each press inserts a value from **0** to **9** to the selected digit. Once the value **9** has been reached, pressing the button again restarts from the value **0** and so on.

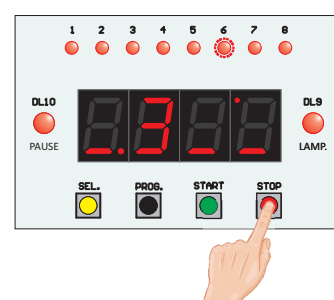
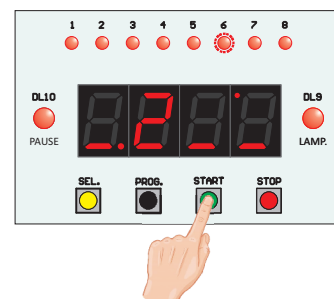

To exit the PROGRAMMING mode, press the **PROG. MEM.** button: in this way the time appearing on the display will be saved in the memory with the number indicated by the lighting up of one of the **8 red LEDs** (for example, if upon exiting PROGRAMMING mode the LED number 6 is on, the time just programmed will be saved in the memory as Time number 6).

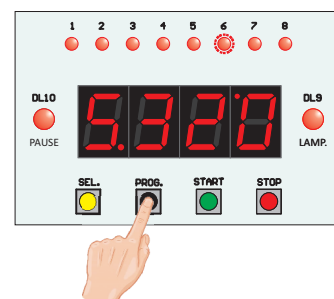

## PROGRAMMING THE "PEDAL" SOCKET

The **PEDAL SWITCH** socket (**jack**) can be set with TWO different working modes:

- **FOCUS**: turning the enlarger lamp ON and OFF without timing.
- **START/STOP** the Timer: to start and stop the Timer without using the buttons.

To correctly activate the **FOCUS** function or the **START/STOP** function, only PEDALS or CONTACTS must be **Normally Open type (N.O.)**.

To set one of the TWO operating modes of the PEDAL, press and hold down the **STOP** button for at least 2 seconds until the number **0** or **1** appears on the display, as specified in the following paragraphs.  
**The push button near to the PEDAL jack has the same function of the pedal.**

**NOTE** - The operating mode of the PEDAL is memorized in the memory of the microcontroller: for this reason, after each Power-On, the Timer always operates with the last mode set by the user.

### START/STOP function

If the display shows the digit **1**, the **PEDAL** socket is programmed as "Start/Stop" (**START/STOP** function). In this way the Timer can be started both by the **START** button or by the **PEDAL**.

To stop and abort the count, press the PEDAL a second time (otherwise, to put the Timer in PAUSE, press the **STOP** button).

**NOTE** - Even when the Timer has been started with the **START** button, it is also possible to stop it with the **PEDAL**.

**NOTE** - The use of the Timer with the **PEDAL** does not allow the **PAUSE** of the count: the pause can **ONLY** activate by the first pressure of the **STOP** button.

**NOTE** - If the count is **PAUSED**, to restore it, is necessary to press the **START** button because when the Timer **PAUSED**, the **PEDAL** socket is not active.

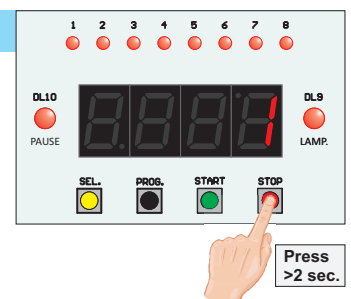

### FOCUS function

If the display shows the digit **0**, the **PEDAL** socket is programmed as "Focus" (**FOCUS** function): enlarger lamp ON and OFF by PEDAL, without timing.

When the PEDAL socket is programmed as **FOCUS**, each pressure of the pedal (or of any other actuator connected to the socket) turns on the enlarger lamp without timing.

When switching on the lamp with the FOCUS function, all the LEDs are off (except for the **LAMP LED**) and **4 dashes (----)** are shown on the display.

To turn off the enlarger lamp, press the PEDAL again (or press the **STOP** button) and the Timer will return to normal operating status.

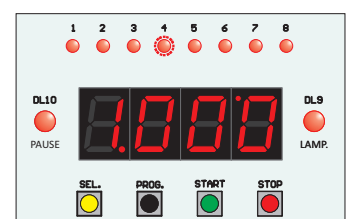
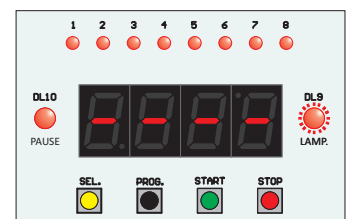
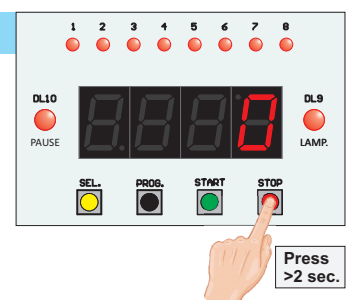

# WIRING DIAGRAM of DR-841 Board

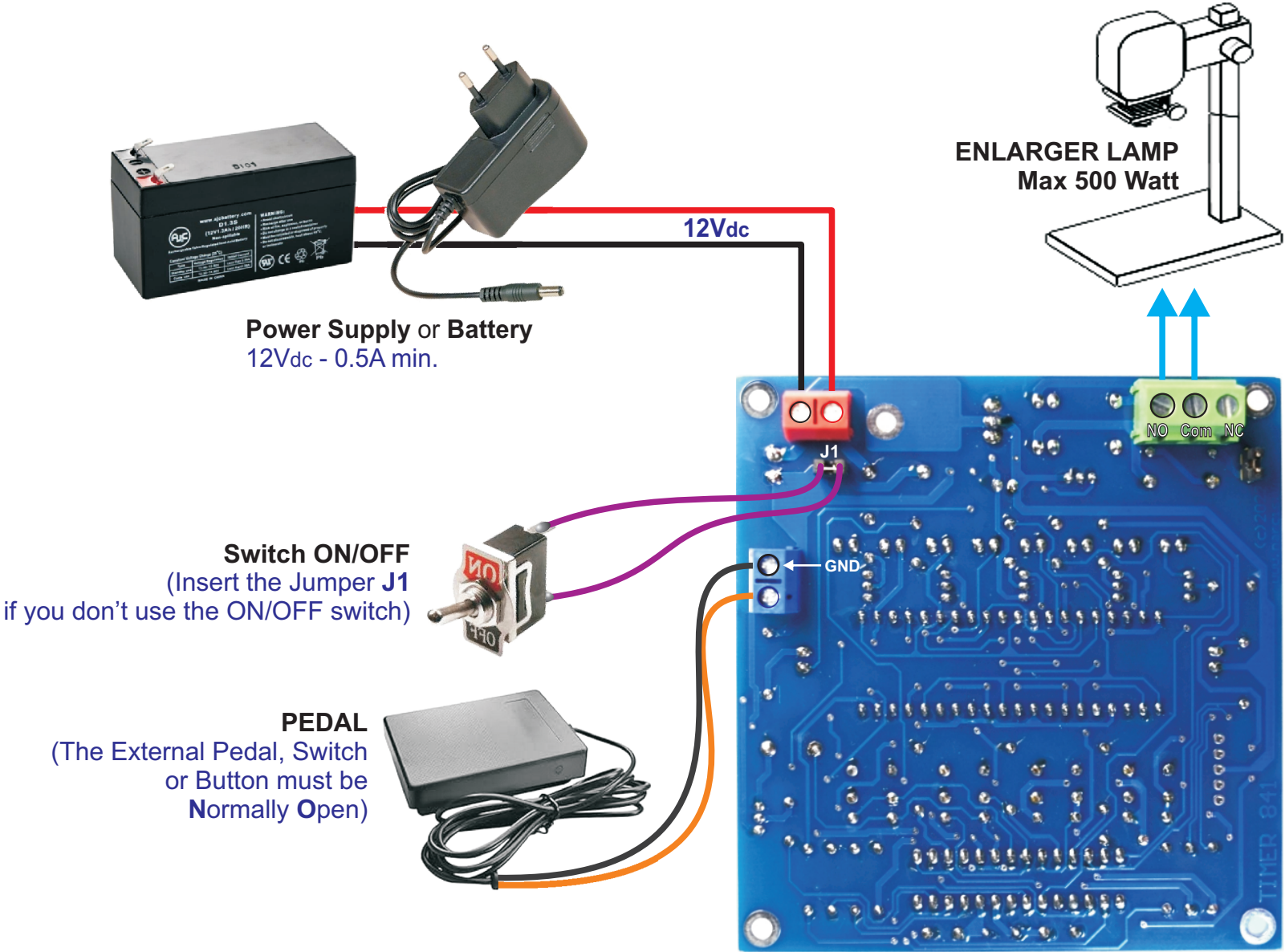



# CONNECTING the ENLARGER LAMP

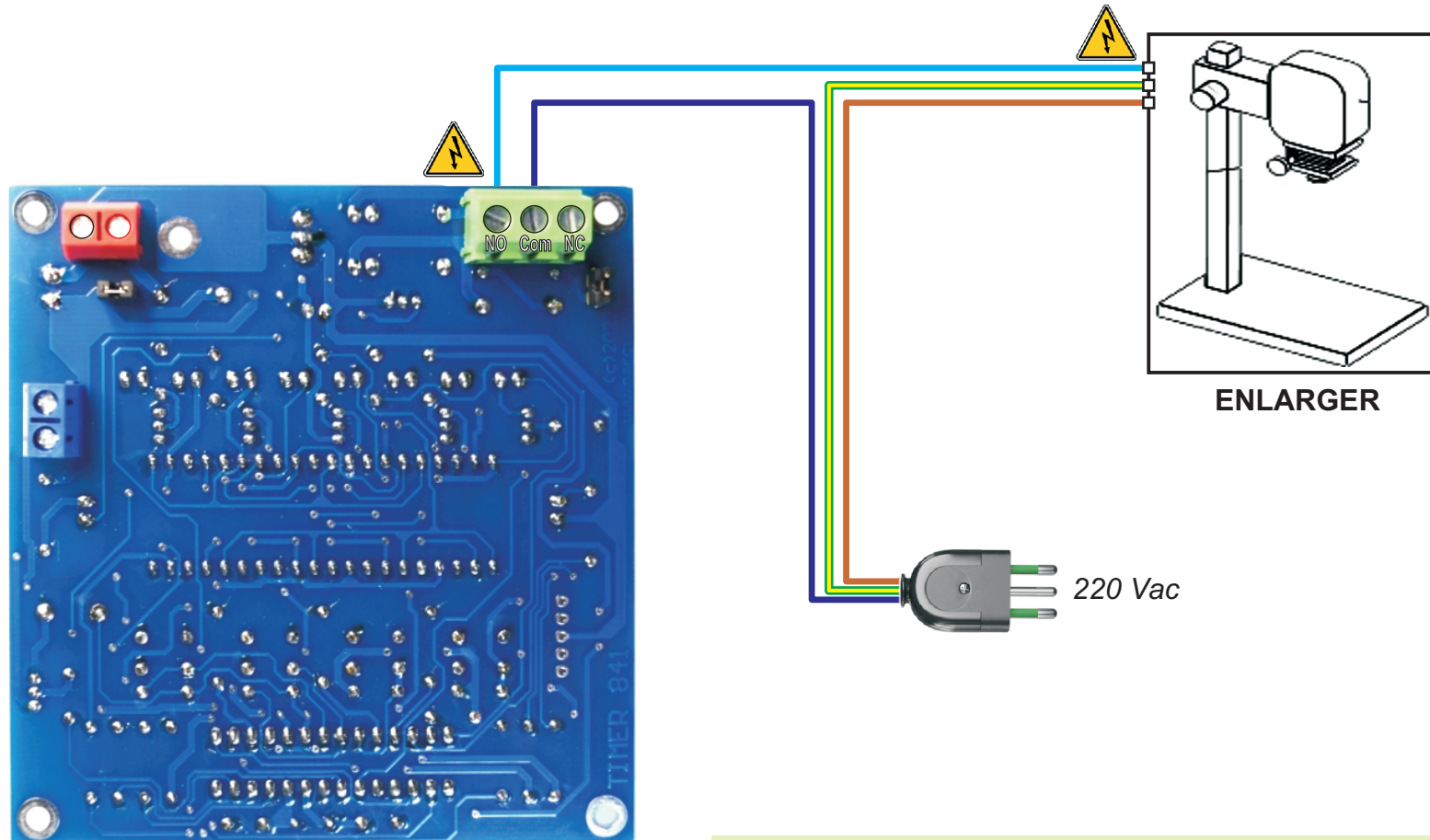

**WARNING !**  
**CONNECTION TO THE MAINS HIGH VOLTAGE.**

*Any connection to the HIGH VOLTAGE it must be performed only by EXPERT STAFF and only afterwards having disconnected the device from the mains.*

# CONNECTING TWO LAMPS

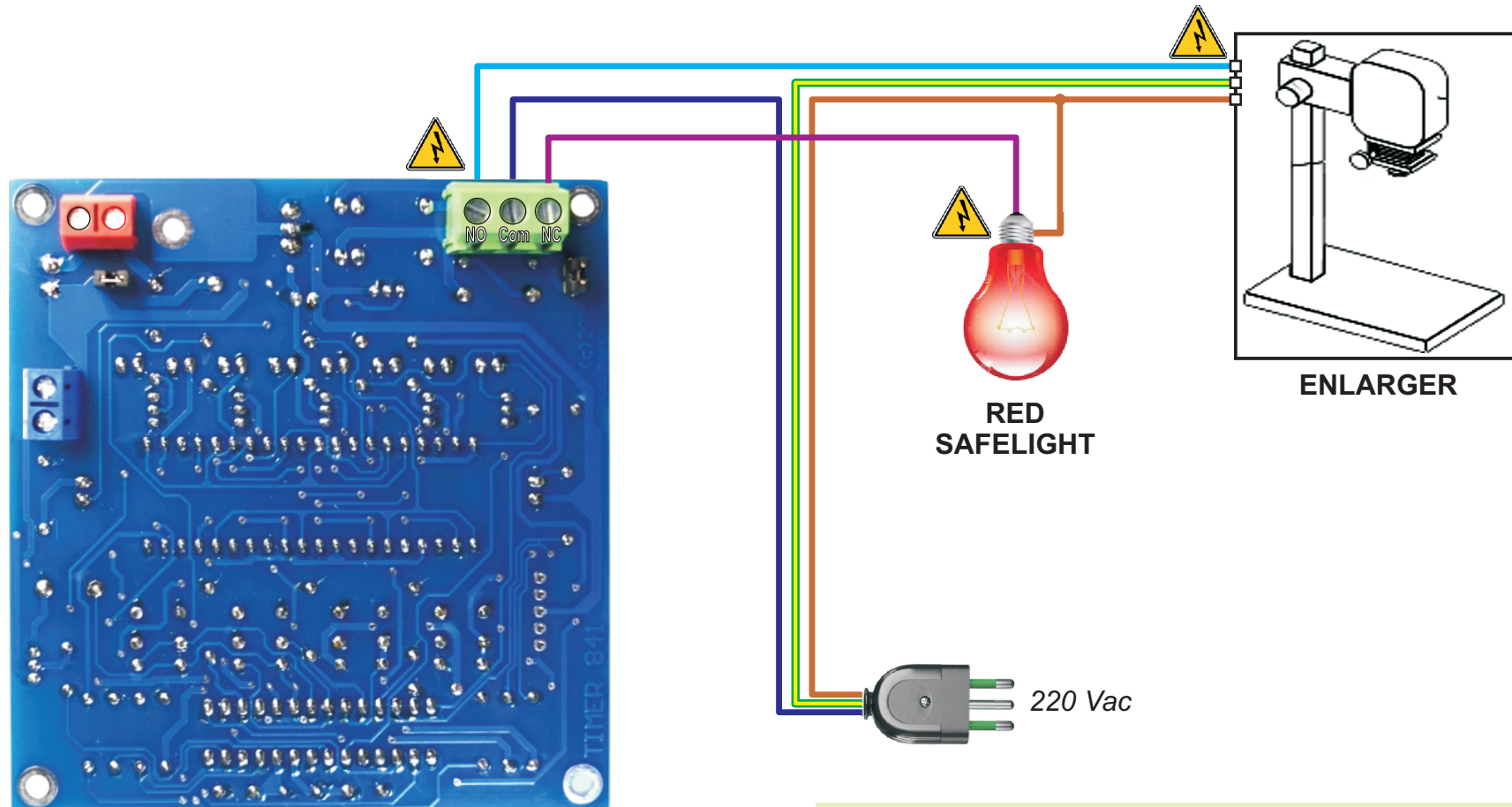

**WARNING !**  
**CONNECTION TO THE MAINS HIGH VOLTAGE.**

*Any connection to the HIGH VOLTAGE it must be performed only by EXPERT STAFF and only afterwards having disconnected the device from the mains.*

# HOW TO CONNECT an EXTERNAL RELAY

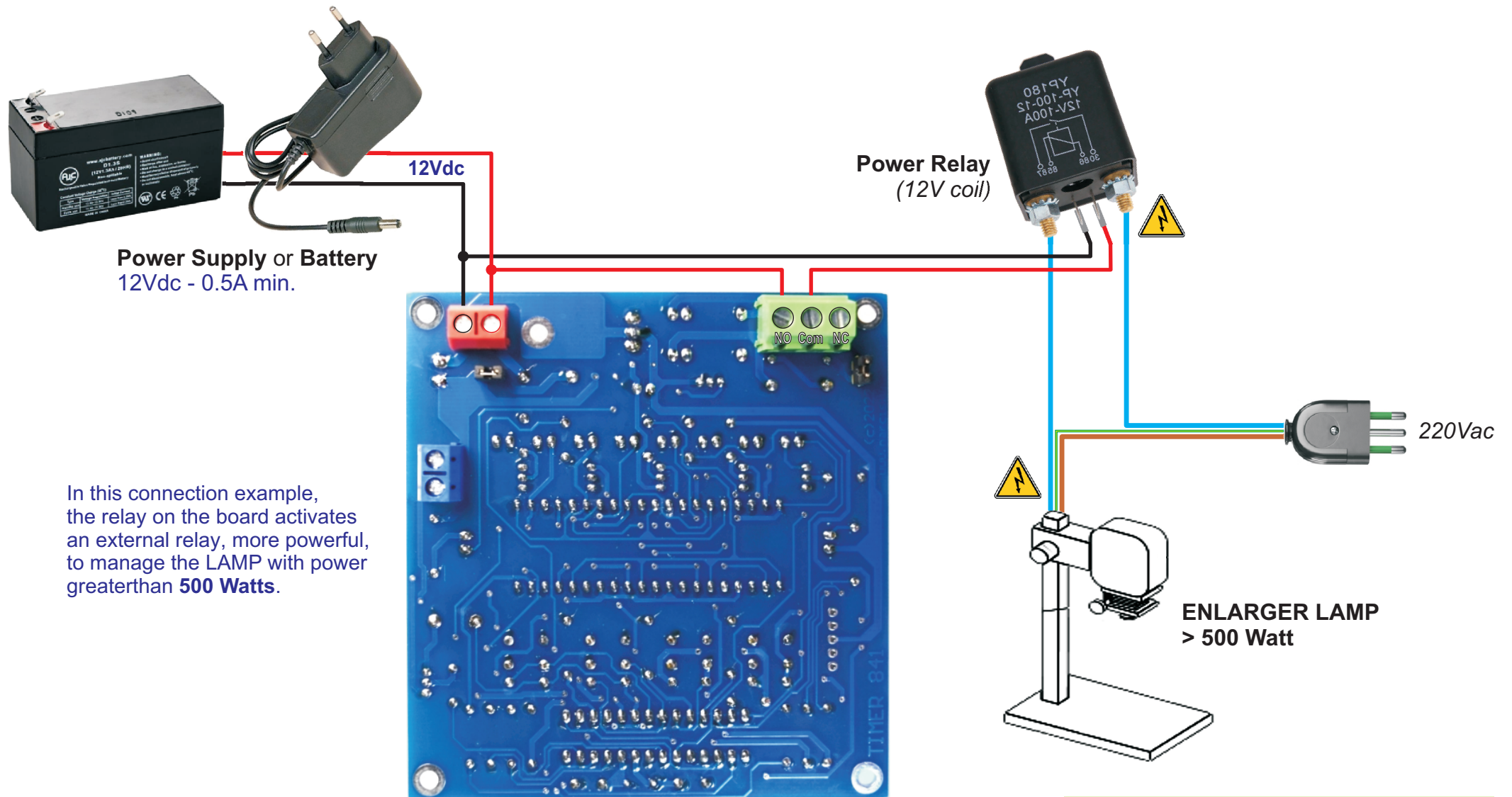

**WARNING !**  
**CONNECTION TO THE MAINS HIGH VOLTAGE.**  
Any connection to the HIGH VOLTAGE it must be performed only by EXPERT STAFF and only afterwards having disconnected the device from the mains.

# DIMENSIONS and HOLES / DIMENSIONI e FORI

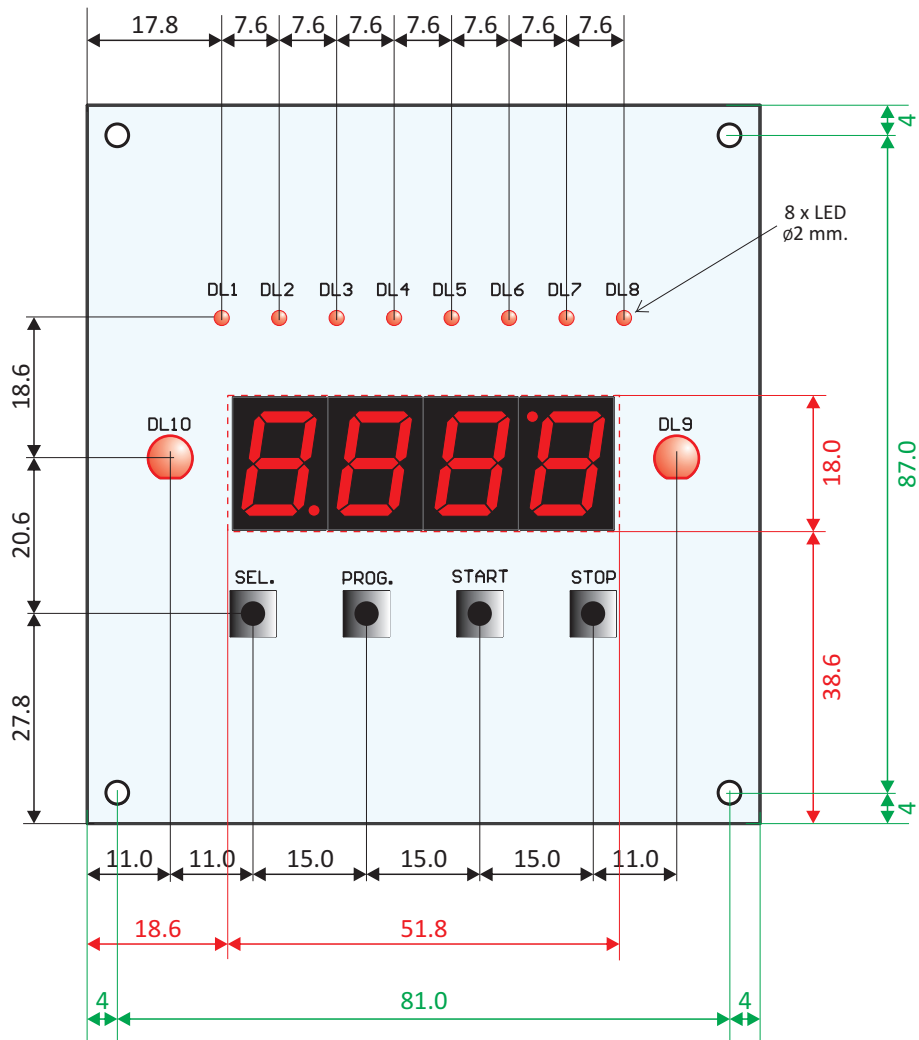

Board Dimensions (Dimensioni scheda): **89 x 95 mm.**  
DL10 (LED "PAUSE") and DL9 (LED "LOAD"):  $\varnothing 3$  or  $\varnothing 5$  mm.  
DL1-DL8 (Selected Time - Tempo Selezionato):  $\varnothing 2$  mm.